

## QUBO SQUARE 51

**COD QS08151101**

Consolle incasso 81  
Recessed console 81  
monoforo / one tap hole

### Disponibilità colori



**cod. 01**  
Bianco Lucido  
White Gloss



**cod. 51**  
Bianco Opaco  
White Matt



**cod. 52**  
Nero Opaco  
Black Matt



**cod. 02**  
Nero Lucido  
Black Gloss



**cod. 53**  
Grigio Bromo  
Grey Bromine

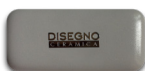

**cod. 56**  
Grigio Perla  
Pearl Grey



**cod. 55**  
Castoro  
Beaver



**cod. 54**  
Tortora  
Turtle-Dove

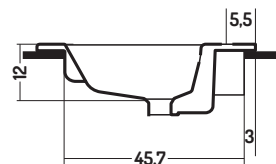
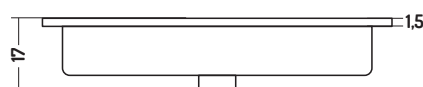
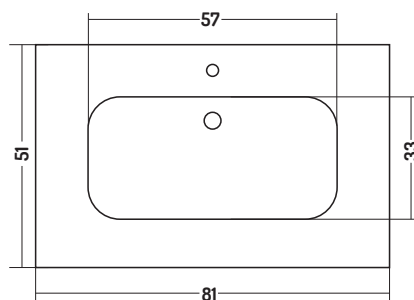

### Caratteristiche



**Smalto**  
Antibatterico  
Antibacterial  
Glaze

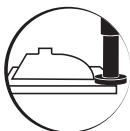

**Lavabo**  
Rettificato  
Grind Basin



**Facilità di pulizia**  
Easy to Clean

#### DISEGNO CERAMICA SRL

Via del Bocciodromo snc  
01035 Gallese Scalo (VT) ITALY

Tel. +39.0761.496725  
Fax +39.0761.496726

info@disegnoceramica.com

#### Ufficio Commerciale ITALIA

giacinta@disegnoceramica.com  
annamosi@disegnoceramica.com

#### Ufficio Export

novella@disegnoceramica.com  
natalie@disegnoceramica.com

#### Ufficio Tecnico

ufficiotecnico@disegnoceramica.com